

CORNER ELEMENTS

4 pieces- basic frame 52x52 cm
(fig.: including SET UP SUPPORT, optional)

CENTRE SUPPORT

Consists of plug in elements with integrated screw connection

ACCESSORY BAG

Yellow bag for mounting accessories

PROJECTION SCREEN BAG

Lined storage bag for folded projection screen
(Optional transport tube for rolled delivery)





SOFTBAG WITH WHEELS

padded, tearproof nylonbag
with wheels and carrying straps
small 128x25x30 cm
big 133x31x35 cm
(optional Flightcase)

FULLWHITE FRAME

Modular plug-in frame system
Basic frame (4 corners 52x52 cm),
Frame components in custom length
Fullwhite compact: standard and
supplementary frame components
in short lengths for small transport volume

ASSEMBLY INSTRUCTION

INDEX

GENERAL	5
STANDARDS, REGULATIONS AND TECHNICAL SPECIFICATION	5
SAFETY	5-8
OPERATION, MAINTENANCE and SERVICE	8
WARRANTY	9
OVERVIEW	10
FULLWHITE FRAME COMPONENTS	11
CLAMP CONNECTION	10
FRAME MOUNTING WITH SET UP SUPPORT	13
CENTER SUPPORT	14
PIVOT NUTS	17
ATTACHMENT OF SET UP SUPPORT	17
MOUNTING OPTIONS	18
FRAME MOUNTING WITHOUT SET UP SUPPORT	19
ACCESSORIES	21



GENERAL

STANDARDS, REGULATIONS and TECHNICAL SPECIFICATION

This projection screen is in accordance with the safety regulations in DIN standard 19045 and DIN 56950. The screen fabric is comply with DIN 4102 part 1 and the specifications of the according data sheet. For the technical details and projection-specific material parameters please refer to the corresponding product data sheet: www.AVstumpfl.com/projectionmaterials

Detailed data of frame components, legs and projection surface can be found on the type labels on each component and on the labeled soft bags, roller bags or flight cases.

SAFETY

GENERAL INFORMATION FOR THE MANUAL AND SAFETY

This operating manual forms part of the projection screen system and enables a safe and efficient operation. The safety section provides information about important safety aspects for the protection of persons, frame and projection materials. Task-related warnings/notes are also contained in the individual chapters. Read instructions through completely before proceeding and keep for future reference. You can find manuals electronically on our website: www.AVstumpfl.com/downloads

PACKAGING MATERIAL

WARNING

Danger of suffocation!

- Keep packaging material and foils away from children.
- Do not let children play with packaging material.



NOTICE

Unpack without cutter or any other sharp tool to avoid damaging of the projection screen. Remove packaging materials by hand. Unpack projection surface after assembling of the frame.



SET UP-ASSEMBLY

MECHANICAL HAZARDS

WARNING



**Falling
parts**

Danger of injury due to improper assembly. Make sure all frame parts assembled correctly and all hinges and joints are locked before raising screen to standing position. Falling parts can cause severe injury or death!

NOTICE

Projection surface damage in case of faulty assembly or set up. Make sure all frame parts assembled correctly and all hinges and joints are locked before one unfold and attach the projection surface.

CAUTION



Please be careful
not to pinch
your fingers!

FRAME AND LEG COMPONENTS

Foldable snap joints, corner hinges and plug-in connections can lead to injury to the hands (body parts). Please be careful not to pinch your fingers!

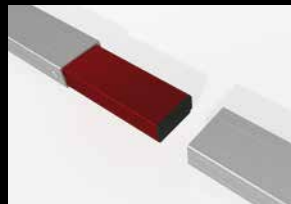
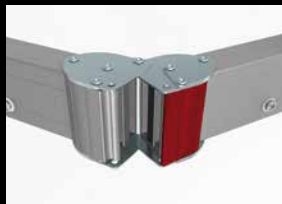

FALLING OVER

WARNING

Falling over of a projection screen can cause severe injury or death!
To avoid falling over:

- Make sure that the projection screen is in level.
- Mind the maximum set-up height of the legs
- Prevent air draft
- Use additional weights on the base profile of the leg to gain higher stability.
- Use suspension points (e.g.: EasyFly) according to the overall system weight for additional safeguarding.

Do not put additional load on the screen frame!
Do not use outdoors!

WARNING

FULLWHITE systems are developed for indoor use only.
Failure to follow warning may result in personal injury due to unforeseen acts of nature.
Any damage and consequential damage caused by outdoor use is not covered by warranty.

BASIC SAFETY REQUIREMENTS

Basic safety requirements for „flying“ projection screens and wall- or ceiling mounting!
If persons are able to stand under the loads, fastening points and slings must not be loaded more than half the value of the load bearing capacity stated by the manufacturer.
When planning the event or production, not only dead loads but also dynamic forces, potential breakdown loads and additional loads during operation, as well as during assembly and dismantling must be taken into account.

Observe the local safety regulations!

FLYING SCREEN

If a modular projection screen is used as a “flying” (free hanging) screen, then all plug-in and clamp connections must be secured against becoming loose and falling.
It is not allowed to use the projection surface holding the frame parts in position!
Falling parts can cause severe injury or death!
Please make sure that all components are secured safely before raising screen to standing position and lifting. Use the necessary number of suspension points according to the overall system weight.
A second/auxiliary safeguarding system is mandatory (e.g. steel rope catch)
Please follow the detailed instruction in the manual.

WARNING



**Falling
parts**

It is not allowed to use the projection surface holding the frame parts in position! Falling projection screens or parts can cause severe injury or death!

WALL- or CEILING MOUNTING

Before mounting, make sure that the wall or ceiling, as well as the fixing points meet the safety requirements of the local standards and the required load can be borne.

WARNING



**Falling
parts**

Danger of injury due to improper disassembly.
Falling parts can cause severe injury or death!

CAUTION



Please be careful
not to pinch
your fingers!

Beware of
pinch points.

DISASSEMBLY

For disassembly the same safety instructions apply as for assembly and set up. Bring down a projection screen with the appropriate number of people to avoid falling over of the screen.

WARNING

Falling parts can cause severe injury or death!



**Falling
parts**

OPERATION, MAINTENANCE and SERVICE

FRAME ELEMENTS, LEGS and ACCESSORIES:

The frame elements, legs and additional elements are maintenance-free.

PROJECTION SURFACE:

The projection surface is packed into a separate lined soft bag to avoid any damage by the frame parts, bleaching and discoloration.

NOTICE

Additionally, following instructions have to be adhered to:

Do not allow the projection surface to get in contact with sharp objects.

Do not bring printed and coloring objects (instructions, magazines, etc.) in contact with the projection surface!

Do not write on the projection surface!

Colors penetrate the projection surface and cannot be cleaned anymore!

Store the projection surface cleaned and dry at room temperature only!

The projection surface has to be folded with the front layer inside; in order to avoid soiling and damage.

When folding the projection surface insert the enclosed foamed plastic foil between snap buttons and surface to avoid permanent marks.

COLD BREAK

A projection foil must never be stored or transported below 5° C. There is a risk of a cold break! The film becomes very brittle and splinters like glass! When transporting the projection surface at low temperatures do not unfold the surface unless it has reached its full elasticity at room temperature. Otherwise there is the risk of cold break of the projection screen.

The ideal temperature range for assembling folding screens to prevent damaging the surface is 54°-82° F (12°-28° C). Assembling below recommended temperatures may damage surface and void warranty

CLEANING OF THE PROJECTION SURFACE

Use a white clean cotton cloth saturated with clear water (optionally mild soap water) and gently wipe the area in one direction (no circular motion). Wipe dry with another cotton cloth.

To clean a stubborn stain, use methylated spirit and follow the same procedure.

Clean rear projection surfaces in case of imperative only!

WARRANTY

The warranty period for production deficiencies is 5 years for the frame elements and 24 months for the projection surface.

NOTICE

Mobile projection screens are developed for indoor use only.
Any damage and consequential damage caused by outdoor use is not covered by warranty.

The general terms and conditions are available at <http://avstumpfl.com/agb>

LIMITATION OF LIABILITY

All the details in this manual were compiled in consideration of the standards and legal regulations applicable at this time, as well as the experience of the manufacturer and qualified staff. The manufacturer accepts no liability for damage to persons or things (projection screen, other devices, goods, etc.) resulting from:

Non-observance of the manual and the regulations/safety instructions contained therein.

- Failure to comply with the local safety regulations.
- Inappropriate use (misuse).
- Use of unauthorized and non-trained staff.
- Unauthorized equipment conversions and technical modifications by the operator himself.
- Use of spare parts not approved by the manufacturer.
- Typesetting and print errors.

Failure to observe the above points will invalidate the warranty claims.
Technical specifications are subject to change without notice.

The local regulations and safety regulations and the essential safety requirements apply for the use of this projection screen.

DISPOSAL

At the end of its lifetime this product must not be disposed of with normal household waste but needs to be taken to a collection site for recycling.

Separate disposal of the product makes an important contribution towards environmental protection.

Frame components and legs are made of aluminum and steel.

The projection material is PVC vinyl.

Contact your local disposal company for the address of a collection center.

Subject to modifications, errors expected !

OVERVIEW

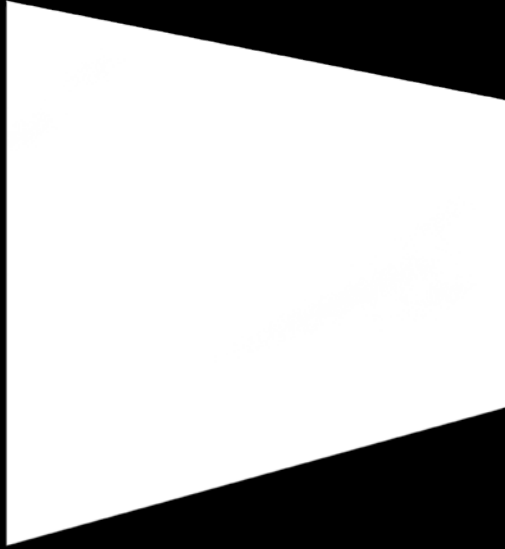

Further development of the mobile projection screens for applications where hidden technology and puristic design is required.

With the minimalistic design this projection screen fits easily in every optical superior installation.

Universal, invisible mounting options as well as high stability and flexibility are essential features of this projection system.

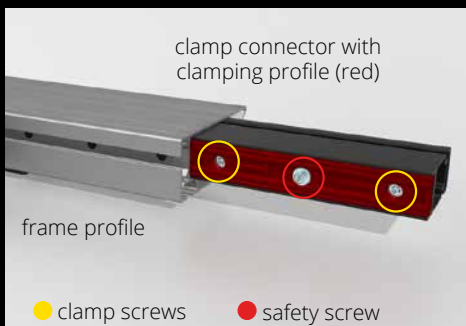

SYSTEM COMPONENTS:

The hollow chamber profile with trapezoid shape gives an extra high stability and allows a perfect wrinkle-free application of the projection surface on the backside of the profile with hooks or Velcro.

The clamp connectors with the patented shape of the clamping profile (red) guarantees a secured and solid connection, like a monolithic system.

The corner parts are designed as a single piece construction with a minimum tolerance, thereby ensuring the highest precision.

FULLWHITE FRAME COMPONENTS

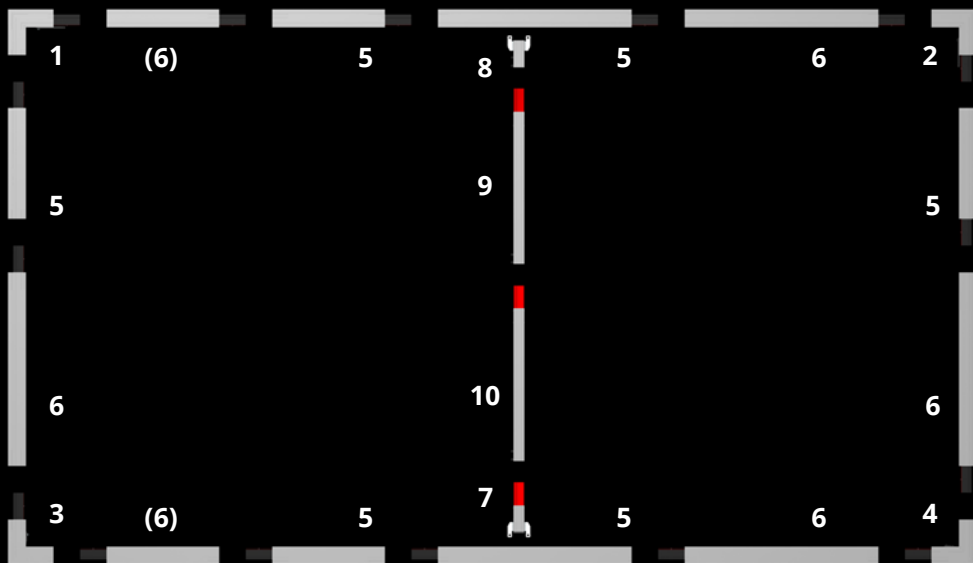

FULLWHITE

All components of the projection screen are labeled. For assembly, start with the basic frame. Place the corner elements 1 to 4 according to drawing above. Afterwards separate the frame components to „horizontal“ and „vertikal“ and halve the number for each frame site.



or



FULLWHITE compact

For small component lengths we recommend the frame assembly according to the following description: Insert the standard elements 5 (110cm) and supplementary frame components 6 (smaller than 110cm) according to their labeling (see sketch above). In case of two supplementary frame components 6 and (6) per frame side, the standard elements 5 (110cm) have to be placed in between of the two supplementary frame components 6 and (6).

CLAMP CONNECTION

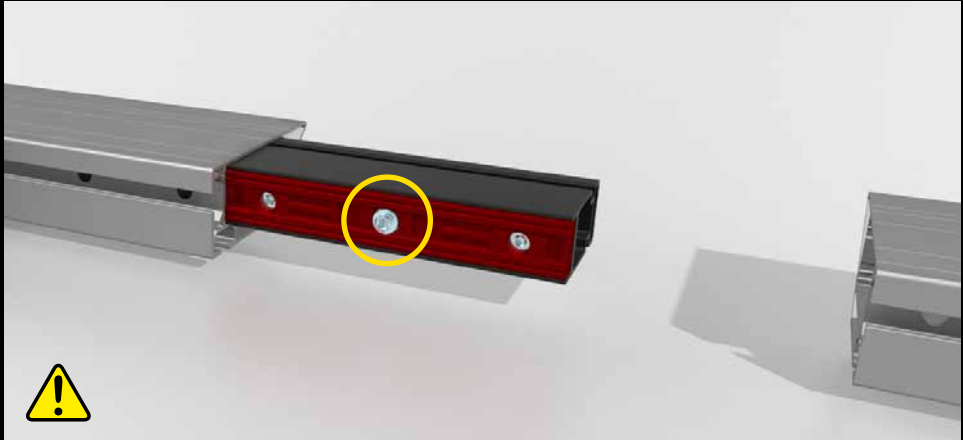

The Fullwhite clamp connector is equipped with a center safety screw.

⚠ CAUTION Beware of pinch points!

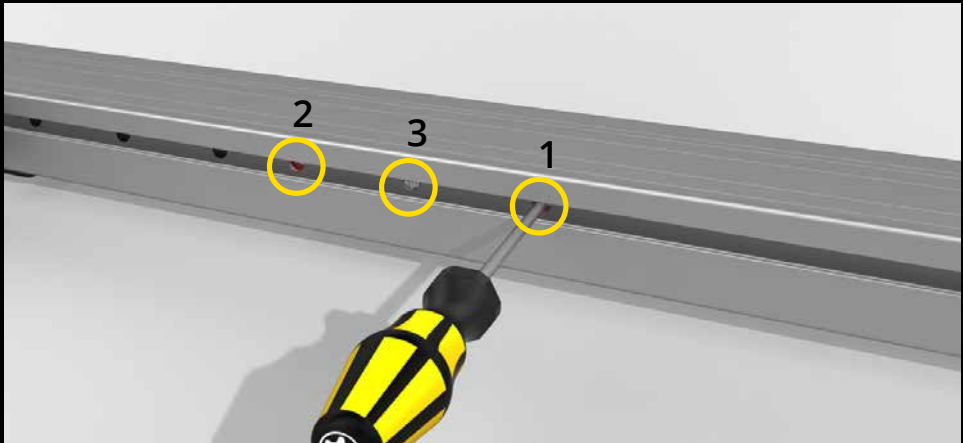

The clamp connection is tightened with the two screws (1&2) and additionally secured with a center safety screw (3). Therefore use the included TORX screwdriver TX25.

FRAME MOUNTING WITH SET UP SUPPORT

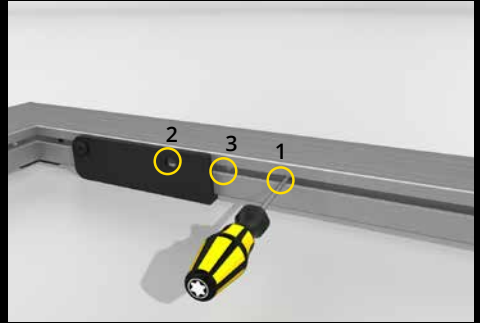
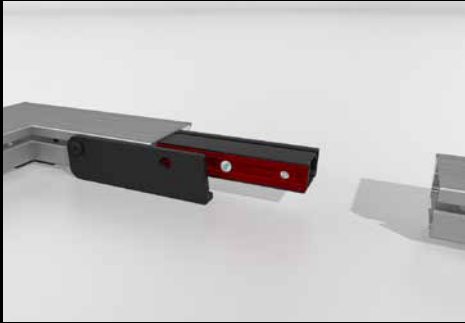

PROTECTIVE FOIL

Before you unroll the projection surface with the projection side down, the floor has to be cleaned completely and the supplied protective foil has to be laid out.

The protective foil is to prevent dirt and damage of the projection surface.

FRAME MOUNTING

Detailed instruction for SET UP SUPPORT (optional accessory) on page 13

NOTE: SET UP SUPPORTS can remain folded up on the frame after mounting.

All components of the projection screen are labeled. For assembly, start with the basic frame. Place the corner elements 1 to 4 according to drawing above. Afterwards separate the frame components to „horizontal“ and „vertikal“ and halve the number for each frame site.

Put together the connected upper and lower horizontal frame elements with corner parts on each end. Clamp the connection by turning the two clamp screws clockwise and secure the connections with the center safety screw. Next plug in the vertical elements, clamp and secure them in the same way. The vertical connections must always be secured with the center safety screw!

In order to meet international safety requirements during flying applications the clamp connection must be locked with the integrated safety screw.

CENTER SUPPORT

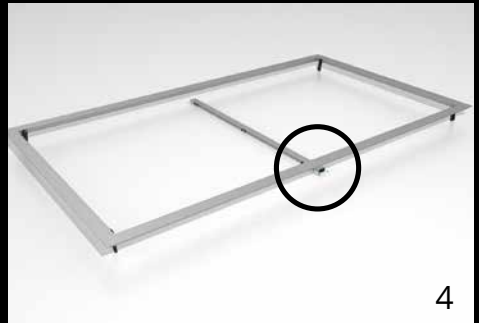
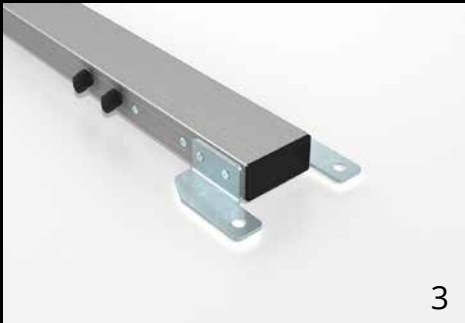
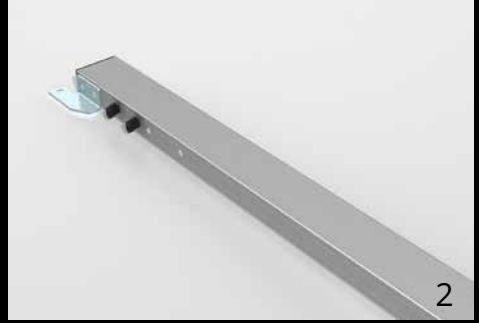
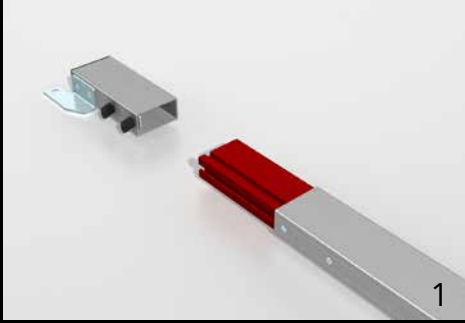

1-2 Put together the center support according to the labels and secure the connections with the two wing nuts.

3 Detach the pivot nuts from the top and bottom center support element and insert them into the inner slot of the horizontal frame bar. (For the insertion of the pivot nut refer to page 13)

4-5 Place the center support and secure it on top and bottom with the Phillips screws. Screwdriver not included.



SURFACE ATTACHMENT

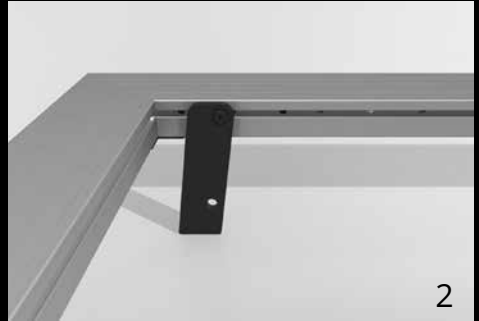
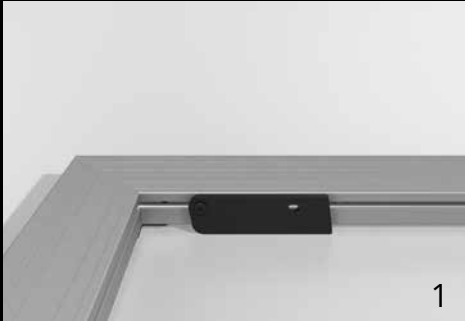

1-2 Foldaway legs hold the projection screen's frame in position above the floor to allow the surface attachment from top.

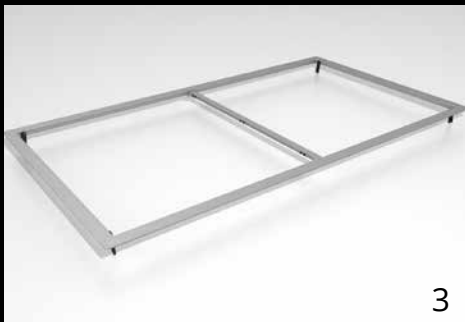

3-4 Lay out the surface on the frame with the label „OBEN-TOP“ corresponding with the upper frame bar. It is necessary to carry out this step with several people to avoid damage of the projection surface.



5-6 Attach the surface by starting at the first corner to fix one vertical and horizontal hook to the corner clip. Repeat this step according to the order in picture **7**.

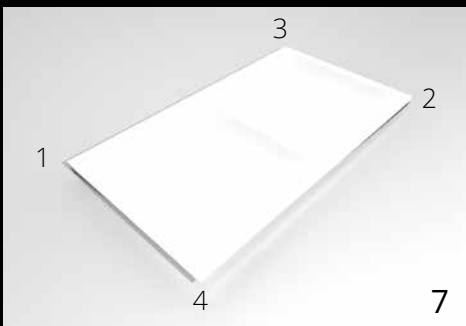

Finally stretch all the remaining hooks one by one over the profile edge and put them into the bottom profile slot.

! Please mind the instructions for projection surfaces in chapter GENERAL on page 5!

PIVOT NUTS

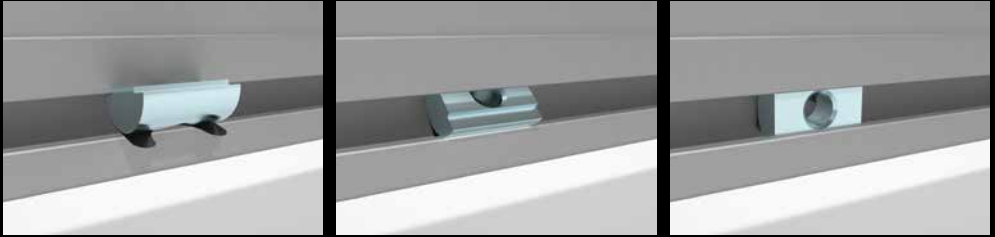

General attachment of pivot Nuts M8 with flexible tongue
(Different to the illustration above, the pivot Nuts M8 for SET UP SUPPORT is equipped with a spring loaded ball)

ATTACHMENT OF SET UP SUPPORT

The installation of the projection surface with large FULLWHITE is done by using SET UP SUPPORTS. Those foldaway legs hold the frame approx. 12 cm above the floor to allow the surface attachment from top.

Laying out the projection surface and the frame on the ground is no longer necessary.
NOTE: SET UP SUPPORTS can remain folded up on the frame after mounting.

The SET UP SUPPORTS are attached to each corner and the remaining ones should be mounted regularly on the horizontal and vertical bars .

Insert the pivot nut into the frame slot and position the SET UP SUPPORT according to the picture below. The additional opening of the SET UP SUPPORT has to be aligned with the screw of the clamp connector to get access for tightening.

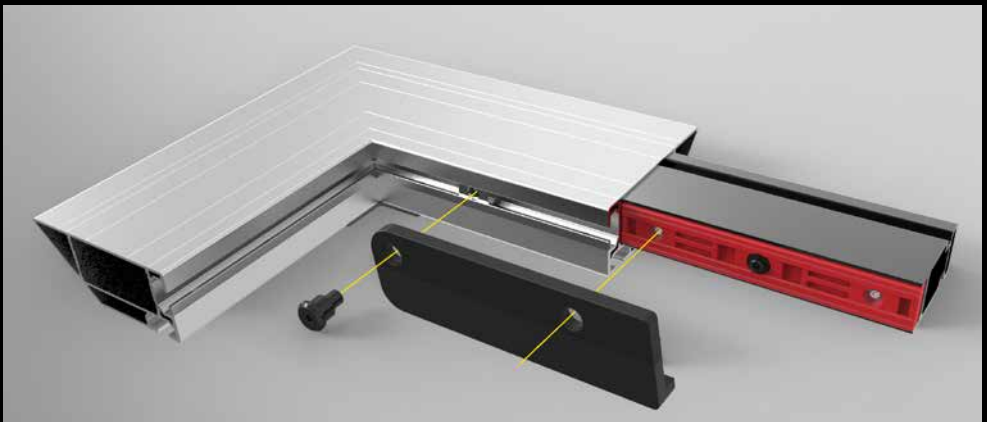

MOUNTING OPTIONS



MOUNTING BRACKET FOR WALL MOUNTING

Optional as vertical or horizontal mounting point

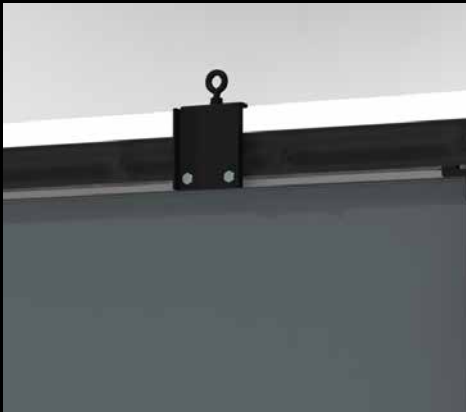

MOUNTING BRACKET FOR CEILING SUSPENSION



MOUNTING BRACKETS FOR LEGS:

Individually movable mounting brackets for legs can be mounted at the inner side of the frame profile.

FRAME MOUNTING WITHOUT SET UP SUPPORT

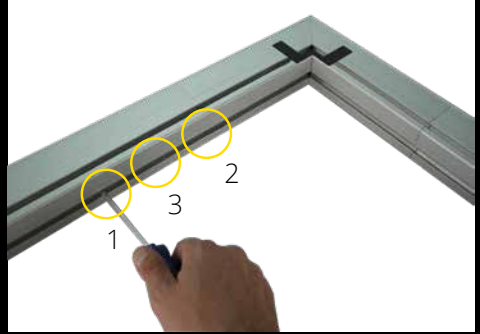

In case of frame mounting without SET UP SUPPORT the profiles have to be placed on the floor with the profile groove to the top .

PROTECTIVE FOIL

Before you unroll the projection surface with the projection side down, the floor has to be cleaned completely and the supplied protective foil has to be laid out.

The protective foil is to prevent dirt and damage to the projection side of the projection surface.

SURFACE MOUNTING

The frame now needs to be placed flat onto the backside of the projection surface according to the photo. This step has to be carried out with several people to avoid any damage of the projection surface!

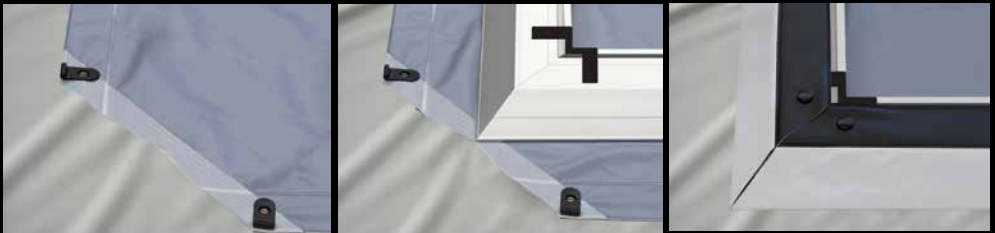

PROJECTION SURFACE WITH HOOKS

Fold the surface to the backside of the frame, tighten it and fix it with the hooks in the slot. The projection surface is kept in position by the special corner clips.



PROJECTION SURFACE WITH VELCRO

Fold the surface to the backside of the frame and tighten it with the Velcro.

ACCESSORIES

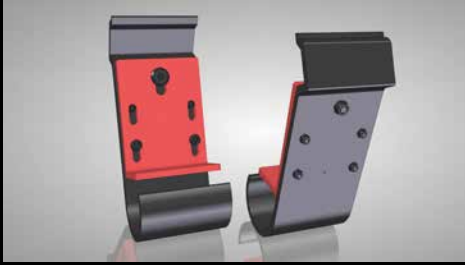

RAISING SUPPORT

The interlock of the raising support has to be secured by pulling back the red angle bracket.

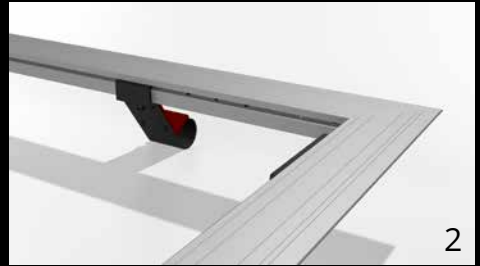

The raising support has to be placed into the inner groove **1** and turned outwards. Doing so will release the interlock and the angle will slide in the bottom groove and secures the raising support **2**. When the surface has been attached to the Fullwhite® projection screen frame and the screen needs to be raised these devices keep the projection screen away from the floor to prevent damaging of the sensitive surface **3**.

⚠ WARNING Falling parts!

CONNECTION BRACKETS AND CONNECTION PLATES

To connect Fullwhite frames, several types of connection are available on request.

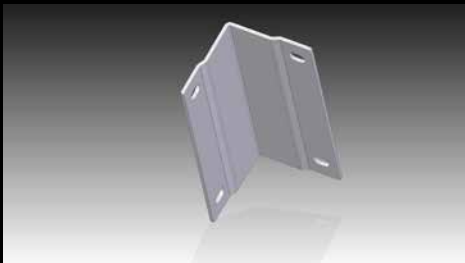

Example 1: Connection bracket outside corner 90°

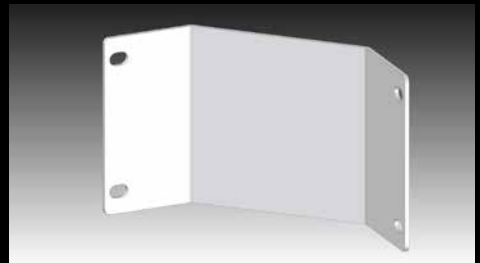

Example 2: Connection bracket inner corner



AV Stumpfl GmbH | Mitterweg 46 | 4702 Wallern
AVstumpfl@AVstumpfl.com | www.AVstumpfl.com | +43 7249 42811