



4K HDR
HDCP 2.2



PRO-F32M

4K HDMI over Fiber 3 x 2 matrix.

OPERATION MANUAL

DISCLAIMERS

The information in this manual has been carefully checked and is believed to be accurate. CYP (UK) Ltd assumes no responsibility for any infringements of patents or other rights of third parties which may result from its use.

CYP (UK) Ltd assumes no responsibility for any inaccuracies that may be contained in this document. CYP (UK) Ltd also makes no commitment to update or to keep current the information contained in this document.

CYP (UK) Ltd reserves the right to make improvements to this document and/or product at any time and without notice.

COPYRIGHT NOTICE

No part of this document may be reproduced, transmitted, transcribed, stored in a retrieval system, or any of its part translated into any language or computer file, in any form or by any means—electronic, mechanical, magnetic, optical, chemical, manual, or otherwise—without express written permission and consent from CYP (UK) Ltd.

© Copyright 2011 by CYP (UK) Ltd.

All Rights Reserved.

Version 1.1 August 2011

TRADEMARK ACKNOWLEDGMENTS

All products or service names mentioned in this document may be trademarks of the companies with which they are associated.

SAFETY PRECAUTIONS

Please read all instructions before attempting to unpack, install or operate this equipment and before connecting the power supply.

Please keep the following in mind as you unpack and install this equipment:

- Always follow basic safety precautions to reduce the risk of fire, electrical shock and injury to persons.
- To prevent fire or shock hazard, do not expose the unit to rain, moisture or install this product near water.
- Never spill liquid of any kind on or into this product.
- Never push an object of any kind into this product through any openings or empty slots in the unit, as you may damage parts inside the unit.
- Do not attach the power supply cabling to building surfaces.
- Use only the supplied power supply unit (PSU). Do not use the PSU if it is damaged.
- Do not allow anything to rest on the power cabling or allow any weight to be placed upon it or any person walk on it.
- To protect the unit from overheating, do not block any vents or openings in the unit housing that provide ventilation and allow for sufficient space for air to circulate around the unit.

REVISION HISTORY

VERSION NO.	DATE	SUMMARY OF CHANGE
v1.00	12/02/2019	First release

CONTENTS

- 1. Introduction6**
- 2. Applications6**
- 3. Package Contents6**
- 4. System Requirements7**
- 5. Features7**
- 6. Operation Controls and Functions8**
 - 6.1 Front Panel 8
 - 6.2 Rear Panel..... 9
 - 6.3 Remote Control 9
 - 6.4 IR Cable Pin Assignments 10
 - 6.5 RS-232 Protocol 10
 - 6.6 RS-232 and Telnet Commands 11
 - 6.7 Telnet Control..... 14
 - 6.8 WebGUI Control 15
- 7. Connection Diagram 21**
 - 7.1 HDMI Switching21
 - 7.2 Fiber Extension22
- 8. Specifications..... 23**
 - 8.1 Technical Specifications23
 - 8.2 Video Specifications.....24
- 9. Acronyms..... 25**

1. INTRODUCTION

This 3x2 HDMI and Fiber Matrix allows customer to route up to three HDMI input signals (two 18Gbps HDMI and one 10.2Gbps HDMI over optical fiber) to any of two HDMI outputs (one 18Gbps HDMI and one 10.2Gbps optical fiber). The optical fiber input and output both support transmission distances up to 300 metres and use paired LC connectors. This unit supports resolutions up to 4K@60Hz (4:4:4, 8-bit), 16-bit Deep Colour up to 1080p@60Hz, HDR (High Dynamic Range), HD audio formats and other features defined by the HDMI 2.0 specification. HDMI sources with bandwidth higher than 10.2Gbps are automatically chroma and/or bit-depth subsampled for transmission over the fiber output. Six pre-defined internal EDIDs and two external EDID selections are available for EDID management. The unit provides intuitive front panel controls as well as RS-232, Telnet, WebGUI and IR remote control options.

2. APPLICATIONS

- /// Entertainment Rooms & Home Theatres
- /// Showrooms & Demo Rooms
- /// Lecture Hall Presentations
- /// Public Commercial Displays

3. PACKAGE CONTENTS

- /// 1x3 by 2 HDMI and Fiber Matrix
- /// 1xRemote Control (CR-155)
- /// 1xIR Extender Cable
- /// 1x3.5mm to 9-pin D-sub Adapter
- /// 1x5V/2.6A DC Power Adaptor
- /// 1xOperation Manual

4. SYSTEM REQUIREMENTS

- /// HDMI source equipment such as media players, video game consoles or set-top boxes.
- /// HDMI receiving equipment such as HDTVs, monitors or audio amplifiers.
- /// The use of “Premium High Speed HDMI” cables is highly recommended.
- /// Use of the optical fiber input/output requires a second unit and appropriate paired LC multi-mode fiber in a crossover configuration.

5. FEATURES

- /// HDMI with 3D & 4K@60Hz with HDR support
- /// DVI 1.0 compliant with the use of an HDMI-DVI adaptor
- /// HDCP 2.2 and 1.x compliant
- /// Supports HD resolutions up to 3840×2160@60Hz (4:4:4, 8-bit) & 4096×2160@60Hz (4:4:4, 8-bit)
- /// Supports 16-bit Deep Colour up to 1080p@60Hz
- /// 2×HDMI (18Gbps) and 1×HDMI over fiber (LC pair, 10.2Gbps) inputs
- /// 1×HDMI (18Gbps) and 1×HDMI over fiber (LC pair, 10.2Gbps) outputs
- /// HDMI sources with bandwidth higher than 10.2Gbps are automatically chroma and/or bit-depth subsampled for transmission over the fiber outputs
- /// Fiber transmission distances of up to 300m
- /// 3×2 matrix routing between all inputs and outputs
- /// Supports pass-through of audio formats: LPCM 2.0/5.1/7.1, Bitstream, and HD Bitstream
- /// Comprehensive EDID management support including 6 pre-defined internal EDIDs and 2 external EDIDs
- /// Supports control via front panel, WebGUI, Telnet, RS-232, and IR remote

6. OPERATION CONTROLS AND FUNCTIONS

6.1 Front Panel

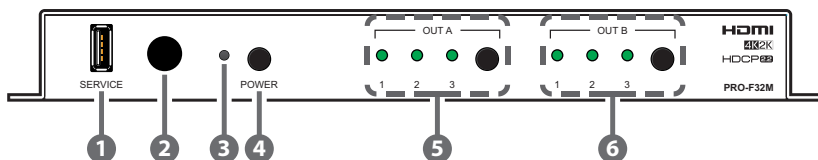

- 1 **SERVICE:** This slot is reserved for firmware update use only.
- 2 **IR WINDOW:** Accepts IR signals from the included IR remote for control of this unit only.
- 3 **POWER LED:** This LED will illuminate green to indicate the unit is on and receiving power. When the unit is in stand-by mode the LED will illuminate red.
- 4 **POWER BUTTON:** Press this button to power the unit on or place it into stand-by mode.

Note: Ethernet, IR and RS-232 remain active while the unit is in stand-by mode.

- 5 **OUT A BUTTON & LEDs:** Press this button to sequentially switch through the 3 available inputs, and mute, for Output A. The LEDs will illuminate to indicate the currently selected input for Output A. When all 3 LEDs are blinking, the output is muted.
- 6 **OUT B BUTTON & LEDs:** Press this button to sequentially switch through the 3 available inputs, and mute, for Output B. The LEDs will illuminate to indicate the currently selected input for Output B. When all 3 LEDs are blinking, the output is muted.

6.2 Rear Panel

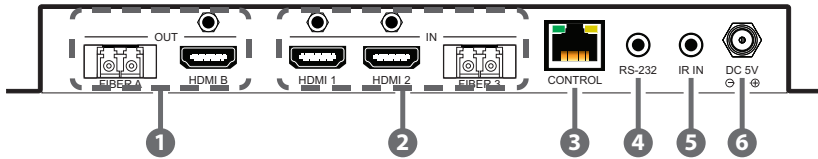

- 1 FIBER A & HDMI B OUT:** Connect the HDMI output to HDMI TVs, monitors or amplifiers for digital video and audio output. DVI displays are supported with the use of an HDMI to DVI adapter. Connect the fiber (paired LC) output to the fiber input on a second unit.
- 2 HDMI 1~2 & FIBER 3 IN:** Connect the HDMI inputs to HDMI source equipment such as media players, game consoles or set-top boxes. DVI sources are supported with the use of an HDMI to DVI adapter. Connect the fiber (paired LC) input to the fiber output from a second unit.
- 3 CONTROL:** Connect directly, or through a network switch, to your PC/ laptop to control the unit via Telnet/WebGUI.
- 4 RS-232:** Connect, via the provided 9-pin adapter cable, to a PC, laptop or other serial control device to send RS-232 commands to control the unit.
- 5 IR IN:** Connect to the provided IR Extender to extend the IR control range of the unit. Ensure that the remote being used is within direct line-of-sight of the IR Extender.
- 6 DC 5V:** Plug the 5V DC power adapter into the unit and connect it to an AC wall outlet for power.

6.3 Remote Control

- 1 POWER:** Press this button to power the unit on or place it into stand-by mode.
- 2 A1~A3 & B1~B3:** Press any of these buttons to switch immediately to the corresponding input for the specified output (A or B).

Note: A4 & B4 have no function with this unit.

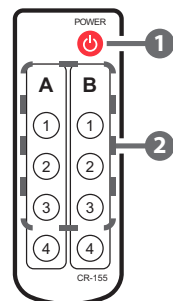

6.4 IR Cable Pin Assignments

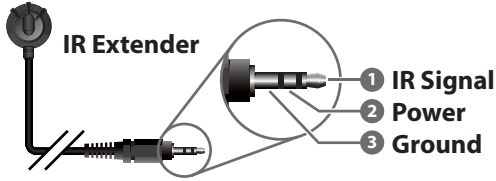

6.5 RS-232 Protocol

UNIT			REMOTE SYSTEM	
Pin	Definition		Pin	Definition
1	NC		1	NC
2	TxD		2	RxD
3	RxD		3	TxD
4	NC	▶	4	NC
5	GND	◀	5	GND
6	NC		6	NC
7	NC		7	NC
8	NC		8	NC
9	NC		9	NC

Baud Rate: 115200bps

Data Bits: 8

Parity Bits: None

Stop Bits: 1

Flow Control: None

6.6 RS-232 and Telnet Commands

COMMAND	DESCRIPTION AND PARAMETERS
HELP	Displays all available commands.
?	Displays all available commands.
P0	Turn unit's power off. (Stand-by mode)
P1	Turn unit's power on.
INNAME N1 N2	Set input N1 to name N2 . N1 = 1 ~ 3 [Input number] N2 = {name} [16 characters max]
INNAME ?	Show the current input names.
OUTNAME N1 N2	Set output N1 to name N2 . N1 = A ~ B [Output letter] N2 = {name} [16 characters max]
OUTNAME ?	Show the current output names.
OUT N1 N2	Set the input/output routing. N1 = A ~ B [Output letter] N2 = 0 ~ 3 [Input number. 0 = Mute]
OUT ?	Show the current input/output routing.
SOURCEDET	Show all source information.
SINKINFO	Show all sink information.
HDCPIN N1 N2	Set the HDCP mode for input N1 . N1 = 1 ~ 3 [Input number] Available values for N2 : 1 [Follow In] 2 [Follow Out] 3 [Apple Mode]
HDCPIN ?	Show the current HDCP input settings.

COMMAND	DESCRIPTION AND PARAMETERS
EDIDMODE N1	<p>Set the EDID mode.</p> <p>Available values for N1:</p> <p>1 [All] 2 [Appoint]</p>
EDIDMODE ?	Show the current EDID mode setting.
EDIDALL N1	<p>Set the EDID to use in "All" mode.</p> <p>Available values for N1:</p> <p>1 [FHD/2CH] 2 [FHD/MCH] 3 [4K UHD/2CH] 4 [4K UHD/MCH] 5 [4K UHD+/2CH] 6 [4K UHD+/MCH] 7 [SINK A] 8 [SINK B]</p>
EDIDALL ?	Show the current EDID selection for "All" mode.
EDIDIN N1 N2	<p>Set the EDID to use on input N1 in "Appoint" mode.</p> <p>N1 = 1 ~ 3 [Input number]</p> <p>Available values for N2:</p> <p>1 [FHD/2CH] 2 [FHD/MCH] 3 [4K UHD/2CH] 4 [4K UHD/MCH] 5 [4K UHD+/2CH] 6 [4K UHD+/MCH] 7 [SINK A] 8 [SINK B]</p>
EDIDIN ?	Show the current EDID selection for each input in "Appoint" mode.
HDMIOUTSCALE N1	<p>Set the HDMI output scaler mode.</p> <p>Available values for N1:</p> <p>1 [Bypass] 2 [4K2K@60_420 to 444]</p>

COMMAND	DESCRIPTION AND PARAMETERS
HDMIOUTSCALE ?	Show the current HDMI output scaler mode.
IPCONFIG	Show the current IP configuration.
SETIP N1 N2 N3	Set the IP Address, Netmask, and Gateway for the unit when in Static IP mode with a single command. Disables DHCP. N1 = X.X.X.X [X = 0 ~ 255, IP Address] N2 = X.X.X.X [X = 0 ~ 255, Netmask] N3 = X.X.X.X [X = 0 ~ 255, Gateway]
SIPADDR N1	Set the IP Address. Disables DHCP. N1 = X.X.X.X [X = 0 ~ 255]
SNETMASK N1	Set the Ethernet netmask. Disables DHCP. N1 = X.X.X.X [X = 0 ~ 255]
SGATEWAY N1	Set the Ethernet gateway. Disables DHCP. N1 = X.X.X.X [X = 0 ~ 255]
RSTIP	Reset the unit's Ethernet mode to DHCP.
ECHO N1	Enable or disable echo when using the console. Available values for N1 : 0 [Off] 1 [On]
ECHO ?	Show the current console echo state.
FADEFAULT	Reset the unit to the factory defaults.
VER	Show the unit's current firmware version.
REBOOT	Reboot the unit.
ETH_FADEFAULT	Reset all Ethernet settings to the factory default.

Note: Commands will not be executed unless followed by a carriage return. Commands are not case-sensitive.

6.7 Telnet Control

Before attempting to use Telnet control, please ensure that both the unit and the PC/Laptop are connected to the same active networks.

To access Telnet	
In Windows 7	Click Start , type “cmd” in the search field, and press Enter .
In Windows XP	Click Start > Run , type “cmd”, and press Enter .
In Mac OS X	Click Go > Applications > Utilities > Terminal .

Once in the CLI (Command Line Interface) type “telnet” followed by the IP address of the unit and “23”, then hit “Enter”.

```
Microsoft Windows [Version 6.1.7601]
Copyright (c) 2009 Microsoft Corporation. All rights reserved.

C:\Users\Administrator>telnet 192.168.1.50 23
```

This will connect us to the unit we wish to control. Type “help” to list the available commands.

Notes:

Commands will not be executed unless followed by a carriage return.

Commands are not case-sensitive.

If the IP address is changed then the IP address required for Telnet access will also change accordingly.

6.8 WebGUI Control

Device Discovery APP

Please obtain the “Device Discovery” software from your authorised dealer and save it in a directory where you can easily find it.

Connect the unit and your PC/Laptop to the same active network and execute the “Device Discovery” software. Click on “Find Devices on Network” and a list of devices connected to the local network will show up indicating their current IP address. (The unit’s default IP address is 192.168.1.50)

Product Name	Description	IP Address	MAC Address

By clicking on one of the listed devices you will be presented with the network details of that particular device.

Product ID
 Product Name
 MAC Address 00:00:00:00:00:00
 IP Address
 Subnet Mask
 Gateway IP
 DNS
 IP Mode
 Web GUI Port
 Telet Port
 S / N
 Firmware Version
 Hardware Version
 Description
 Web GUI [Web GUI](#)

(1) IP Mode: If you choose, you can alter the static IP network settings for the device, or switch the unit into DHCP mode to automatically obtain proper network settings from a local DHCP server. To switch to DHCP mode, please select DHCP from the IP mode drop-down, then click “Save” followed by “Reboot”.

(2) WebGUI Hotkey: Once you are satisfied with the network settings, you may use them to connect via Telnet or WebGUI. The network information window provides a convenient link to launch the WebGUI directly.

WebGUI Control Page

After connecting to the WebGUI's address in a web browser, log into the unit by entering the appropriate user name and password. The default user name and password are "admin".

Login

Username:

Password:

All primary functions of this unit are controllable via the built in WebGUI, including power control, input selection, EDID management, HDCP management, port labeling, and Ethernet settings. The individual functions will be introduced in the following section.

POWER

POWER:

ROUTING

Output A From:

Output B From:

SOURCE DETECT

INPUT1: CONNECTED
INPUT2: CONNECTED
INPUT3: DISCONNECTED

STATUS

FIBER OUT A: IN 2
HDMI OUT B: IN 1
VERSION: V0.20+1.14

EDID

Mode:

EDID ALL:

HDCP CONTROL

INPUT1:

INPUT2:

INPUT3:

FIRMWARE UPDATE

HDMI OUT B MODE

MODE:

NETWORK SETTING

MAC:

IP Mode:

IP Address:

Net Mask:

Gateway:

HTTP Port:

Telnet Port:

FIBER OUT A INFO

Type: HDMI
Manuf. Name: STD
Device Name: UHD-Matrix
Native Resolution: 3840 x 2160
Color Depth: 8 10 12bits
3D: No
Audio Format: LPCM AC3 DTS E-AC3 MLP DTS+HD

NAMING

INPUT 1:

INPUT 2:

INPUT 3:

OUTPUTA:

OUTPUTB:

HDMI OUT B INFO

Type: HDMI2.0
Manuf. Name: STD
Device Name: UHD-Matrix
Native Resolution: 3840 x 2160
Color Depth: 8 10 12bits
3D: No
Audio Format: LPCM AC3 DTS E-AC3 MLP DTS+HD

Login Configuration

Current Password:

New Password:

Confirm New Password:

1. POWER

The unit can be powered on or off (stand-by mode) from this tab.



2. ROUTING

This tab allows for the selection of the input source for each output. Three inputs and mute (sync only, no video or audio) are selectable. The switch will occur immediately upon selection of a new source.

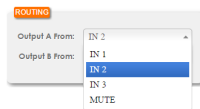

3. EDID

This tab provides EDID management controls for the unit. All inputs can share the same assigned EDID, or each input can have a discrete EDID assigned to it.

- (1) **ALL:** Selecting the “ALL” mode will send the selected EDID to all inputs.
- (2) **APPOINT:** Selecting the “APPOINT” mode allows for each input to have a different EDID assigned to it.

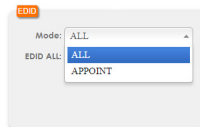

The available EDID options are:

- (1) **FHD/PCM 2CH:** 1080p@60Hz, LPCM 2.0
- (2) **FHD/Bitstream:** 1080p@60Hz, LPCM 7.1 + Bitstream
- (3) **4K UHD/PCM 2CH:** 4K@30Hz, LPCM 2.0
- (4) **4K UHD/Bitstream:** 4K@30Hz, LPCM 7.1 + Bitstream
- (5) **4K UHD+/PCM 2CH:** 4K@60Hz, LPCM 2.0
- (6) **4K UHD+/Bitstream:** 4K@60Hz, LPCM 7.1 + Bitstream

(7) **SINK A:** EDID from the device on Output A

(8) **SINK B:** EDID from the device on Output B

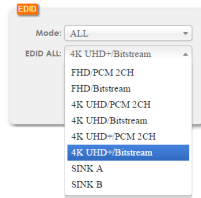

4. HDCP CONTROL

This tab allows for the HDCP mode to be switched between “Follow In”, “Follow Out” and “Apple” mode. “Apple” mode allows for the display of non-HDCP required content from Apple devices on non-HDCP displays. This setting can be assigned individually to each input.

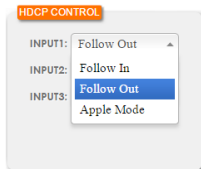

5. HDMI OUT B MODE

This tab allows control over the handling of 4K@60Hz (4:2:0) sources when output from Output B. The signal can be passed unmodified (Bypass) or it can be colour up-sampled from 4:2:0 to 4:4:4 (4K2K@60_420 to 444). Please make the selection that is appropriate based on the capabilities of the connected display.

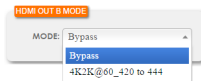

6. NAMING

This tab allows for the renaming of the three Input ports and the two Output ports. Please click the “SAVE” button to store the changes.

NAMING

INPUT 1:

INPUT 2:

INPUT 3:

OUTPUTA:

OUTPUTB:

7. NETWORK SETTING

This tab provides control over the unit’s network settings. The IP mode can be set to DHCP for automatic IP configuration, if your local network supports it, or it can be placed into STATIC mode. When in STATIC mode the IP address, netmask and gateway can be defined manually.

NETWORK SETTING

MAC:

IP Mode:

IP Address:

Net Mask:

Gateway:

HTTP Port:

Telnet Port:

8. LOGIN CONFIGURATION

This tab allows for the login password to be changed. The default password is “admin”.

Login Configuration

Current Password:

New Password:

Confirm New Password:

9. SOURCE DETECT

This tab displays the connection status of the 3 inputs. If a live source is detected on an input it will display “CONNECTED”, if there is no live source it will display “DISCONNECTED”.

SOURCE DETECT

INPUT1: CONNECTED

INPUT2: CONNECTED

INPUT3: DISCONNECTED

10. STATUS

This tab displays the currently selected source for each output and the unit's current firmware version. Options for performing a factory reset or rebooting the unit are also provided here.



11. FIRMWARE UPDATE

This tab provides a way to update the firmware of the unit.

- (1) **Browse:** Click this button to select the firmware update *.bin file which is located on your local PC.
- (2) **Update:** Click this button to begin the firmware update process.

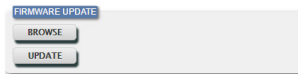

12. FIBER OUT A INFO & HDMI OUT B INFO

These tabs present the information detected from displays connected to the Fiber and HDMI outputs, including type, manufacturer name, native resolution, colour depth, 3D support, and audio format support.

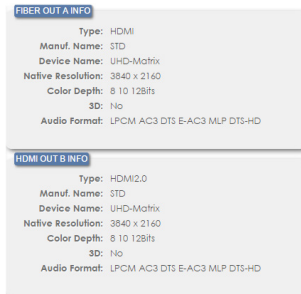

7. CONNECTION DIAGRAM

7.1 HDMI Switching

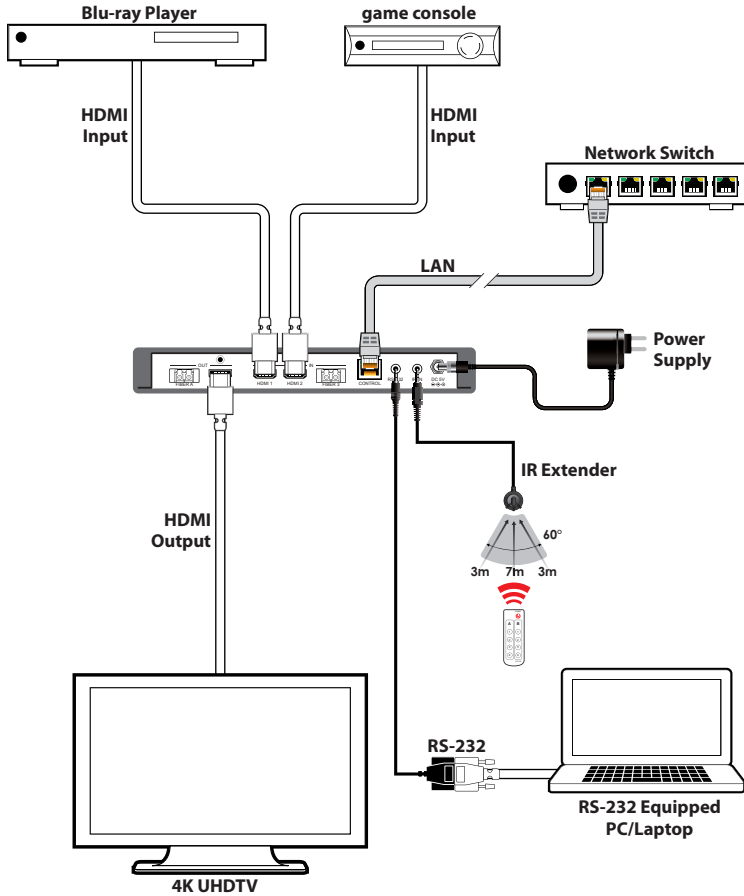

7.2 Fiber Extension

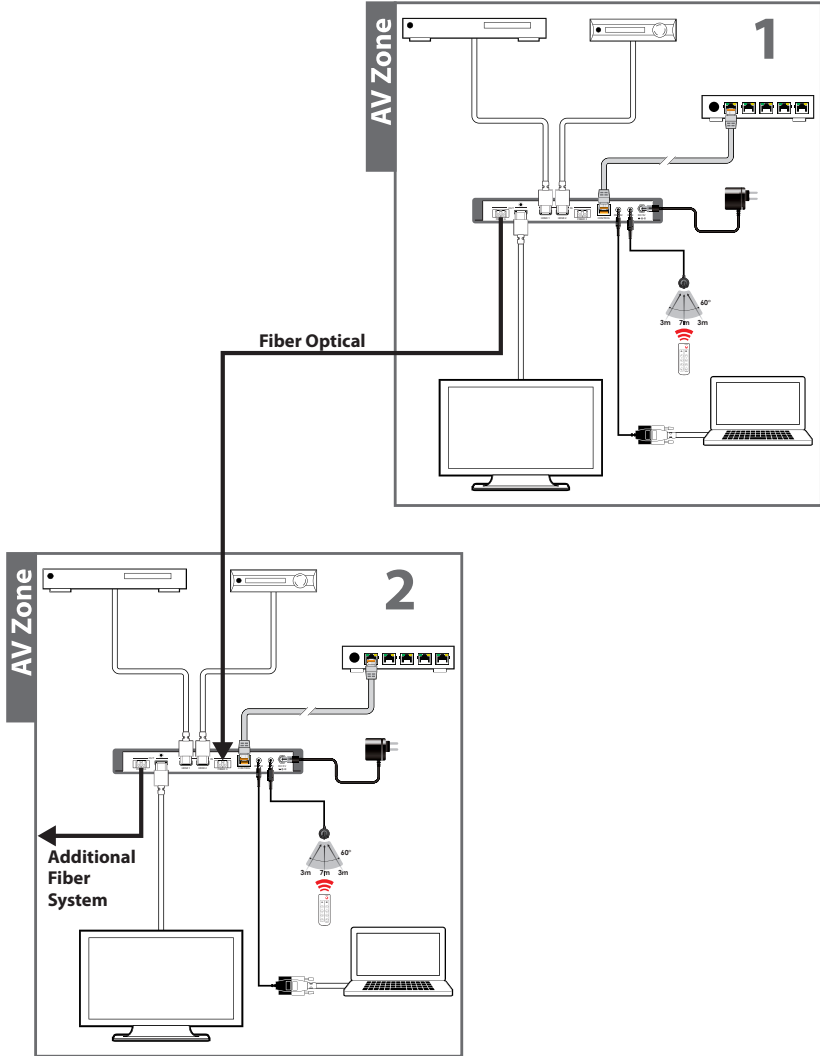

8. SPECIFICATIONS

8.1 Technical Specifications

HDMI Bandwidth	600MHz/18Gbps
Fiber Bandwidth	340MHz/10.2bps
Input Ports	2×HDMI 1×Fiber Optical (Paired LC connector)
Output Ports	1×HDMI 1×Fiber Optical (Paired LC connector)
Control Interfaces	1×IR Extender (3.5mm) 1×RS-232 (3.5mm) 1×IP Control (RJ-45)
HDMI Cable Length	10m (1080p@60Hz, 12-bit) 3m (4K@60Hz, 4:4:4, 8-bit)
Fiber Optical Cable Length	300m with multi-mode OM3 fiber (4K@60Hz, 4:2:0, 8-bit)
IR Frequency	38kHz
Baud Rate	115200bps
Power Supply	5V/2.6A DC (US/EU standards, CE/FCC/UL certified)
ESD Protection	Human Body Model: ±8kV (Air Discharge) ±4kV (Contact Discharge)
Dimensions	240mm×43mm×104mm (W×H×D) [Case Only] 240mm×48mm×112.2mm (W×H×D) [All Inclusive]
Weight	796g
Chassis Material	Metal
Silkscreen Colour	Black

Operating Temperature 0°C - 40°C/32°F - 104°F
Storage Temperature -20°C - 60°C/-4°F - 140°F
Relative Humidity 20 - 90% RH (Non-condensing)
Power Consumption 7.106W (1.10W in stand-by mode)

8.2 Video Specifications

Supported Resolutions (Hz)	Input	Output	
	HDMI	HDMI	Fiber
640×480@60	✓	✓	✓
800×600@60	✓	✓	✓
1024×768@60	✓	✓	✓
1280×1024@60	✓	✓	✓
1600×1200@60	✓	✓	✓
1920×1200@60	✓	✓	✓
480i@60	✓	✓	✓
576i@50	✓	✓	✓
480p@60	✓	✓	✓
576p@50	✓	✓	✓
720p@50/60	✓	✓	✓
1080i@50/60	✓	✓	✓
1080p@24/50/60	✓	✓	✓
3840×2160p@24/25/30	✓	✓	✓
3840×2160p@50/60 (YUV 4:2:0)	✓	✓	✓
3840×2160p@50/60	✓	✓	
4096×2160p@24	✓	✓	✓
4096×2160p@50/60 (YUV 4:2:0)	✓	✓	✓
4096×2160p@50/60	✓	✓	

9. ACRONYMS

ACRONYM	COMPLETE TERM
CLI	Command Line Interface
DVI	Digital Visual Interface
EDID	Extended Display Identification Data
GUI	Graphical User Interface
HD	High-Definition
HDCP	High-bandwidth Digital Content Protection
HDMI	High-Definition Multimedia Interface
HDR	High Dynamic Range
IP	Internet Protocol
IR	Infrared
LAN	Local Area Network
LPCM	Linear Pulse-Code Modulation
PC	Personal Computer
UHD	Ultra-High-Definition
USB	Universal Serial Bus
VGA	Video Graphics Array (640×480@60Hz)
WUXGA	Wide Ultra Extended Graphics Array (1920×1200@60Hz)



CYP (UK) Ltd., Unit 7, Shepperton Business Park, Govett Avenue, Shepperton,
Middlesex, TW17 8BA

Tel: +44 (0) 20 3137 9180 | Fax: +44 (0) 20 3137 6279

Email: sales@cypeurope.com

www.cypeurope.com

v1.00